

What did Jesus do after He told them this?

Use the sign language code key to decipher the answer.

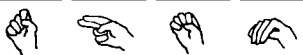
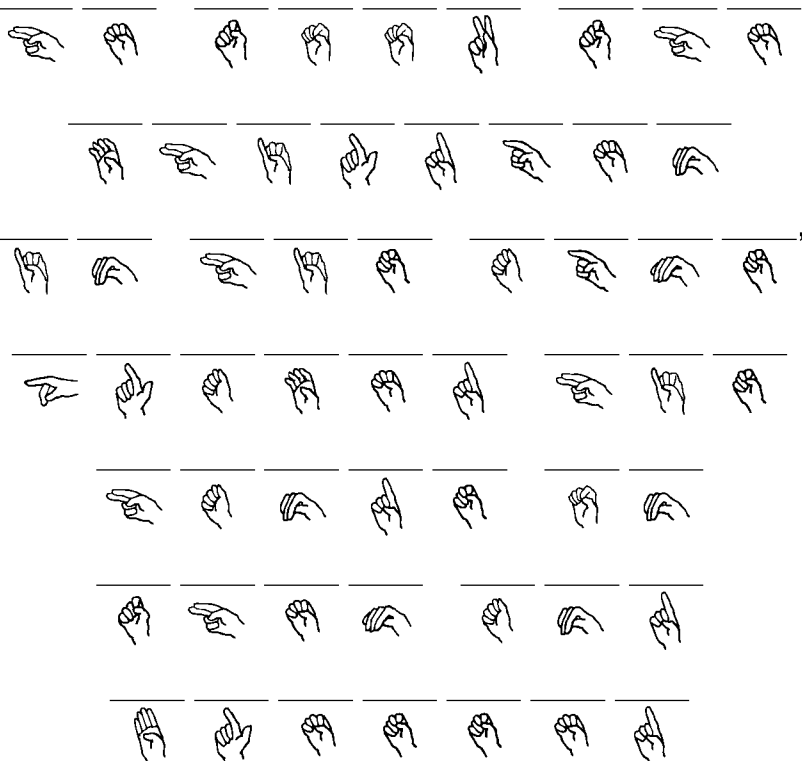
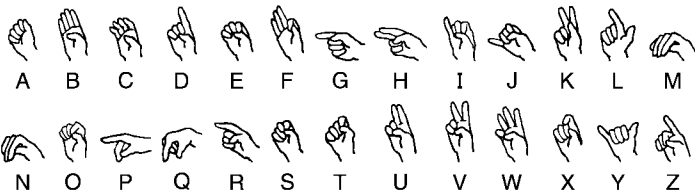

Ages 7+

January 30, 2022 • Mark 10:2-16

Children and Jesus

People were bringing little children to Jesus for Him to bless. But what did Jesus' disciples do?



Follow the correct path through the maze to find the letters to fill in the blanks.

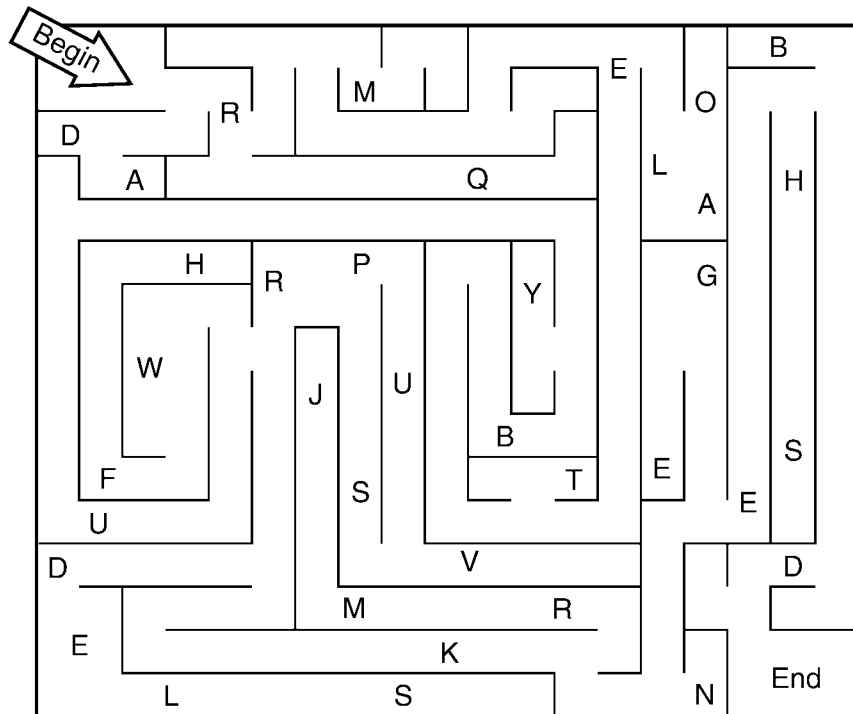

Jesus' disciples _____ them.

Lucas Christian Reformed Church
10479 S. Lucas Rd.
McBain, MI 49657

Worship Serve Love

Enter your **SECRET CODE** to unlock games @ games.childrensbulletins.com

SECRET CODE
WV1029

How did Jesus react to this?

Fill in the word for each picture shown.
Then use the letters in the boxes to fill in the answer below.

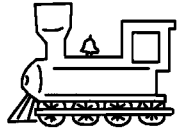

____ _



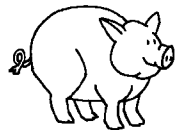

____ _

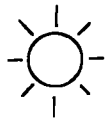

____ _

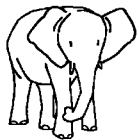

____ _

Jesus was

____ _ .*

*This word means "angry."



What did Jesus say to His disciples?

Unscramble the letters to fill in the blanks.



"Let the 1) _____

2) _____ come to Me,

and do not 3) _____ 4) _____,

for the 5) _____ of 6) _____

7) _____ to 8) _____

as 9) _____."